



Asianda™

**LCD VIDEO WALL**  
**Operation Manual**

English Version

**Attn Customer:**

Thank you for purchasing and choosing Our LCD Video Wall processor, Please check all the the boxes and accessories are in good condition when you open it.Before connecting parts and power, please read this manual and keep this manual for later use.

**Note:**

To use the software,we recommend to copy the content from CD to PC first,othewise,the language may not show in English when you open the CD directly.

**Directory**

**1. Video Wall Controller handle steps**

1.1.Cable connecting	2
1.2.Setting controls	2
1.3. Splicing operation	3
1.4.Main Features	6

**2. Address Code Setting & RJ45 network cable connection**

2.1.Address Code Setting	12
2.2.RJ45 Network Cable Connection	13
2.3.FAQ	14-15

**1. Video Wall Controller handle steps**

**1.1. Step1: cable connecting**

After connecting the signal sources,and COM cable, insert the RJ45 cable into the USB connector then connect to PC.(before connect,ensure the software had been installed on PC. advance.) Then find the COM ID from device management, as below:

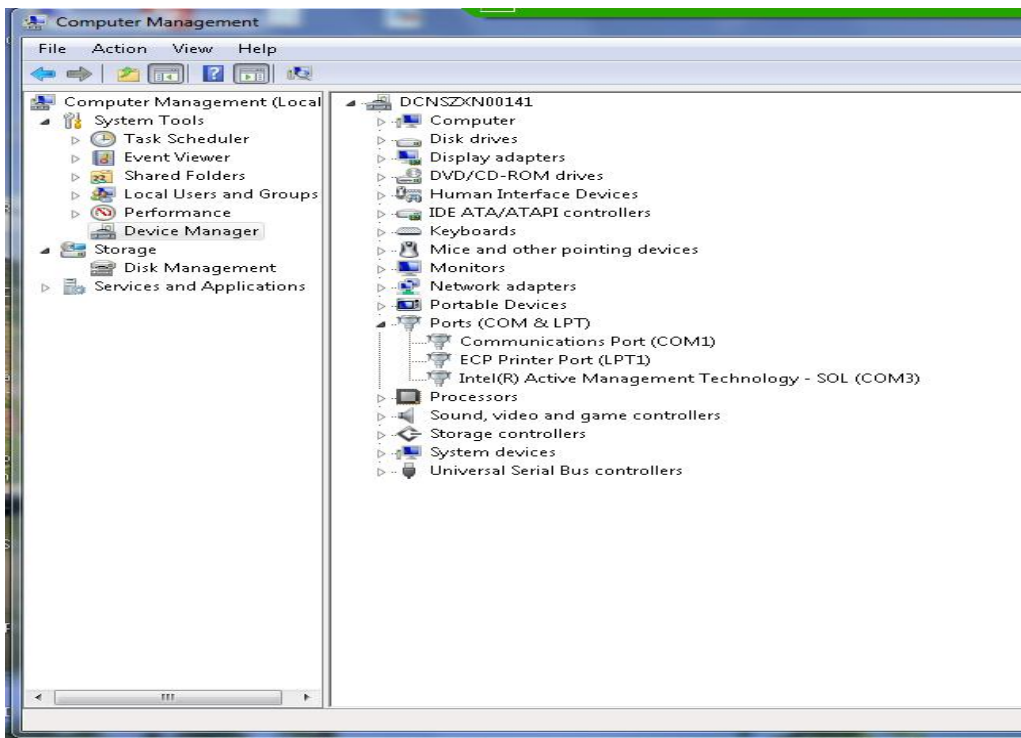

Example, the COM port in this picture is COM1.

## 1.2. Step2:Setting controls

Open KRD Control Software.exe and Click "Com. Setting" in "System Config", select Wireless in Connect Method. Then input IP Address:10.10.100.254 and Port number:8899 as below . Click "Ok" to close the window of Comm Config. Click "Open "&"Close" buttons in "Port Operate", to test the connection availability between software & screens .

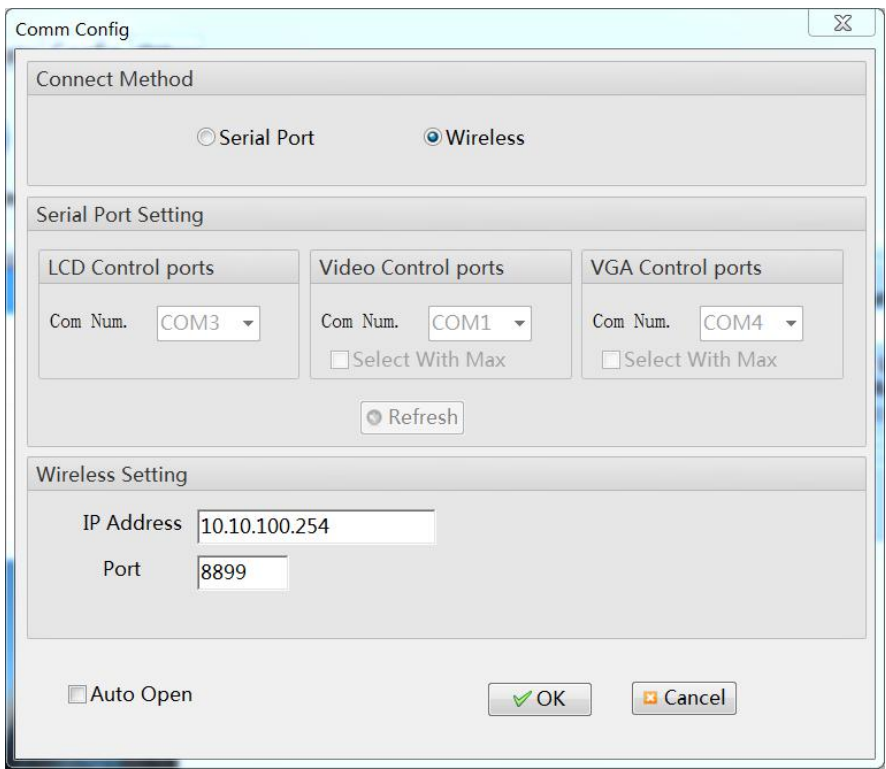

**1.3. Step 3: splicing operation**

Set the "User Name" and "User Logo"

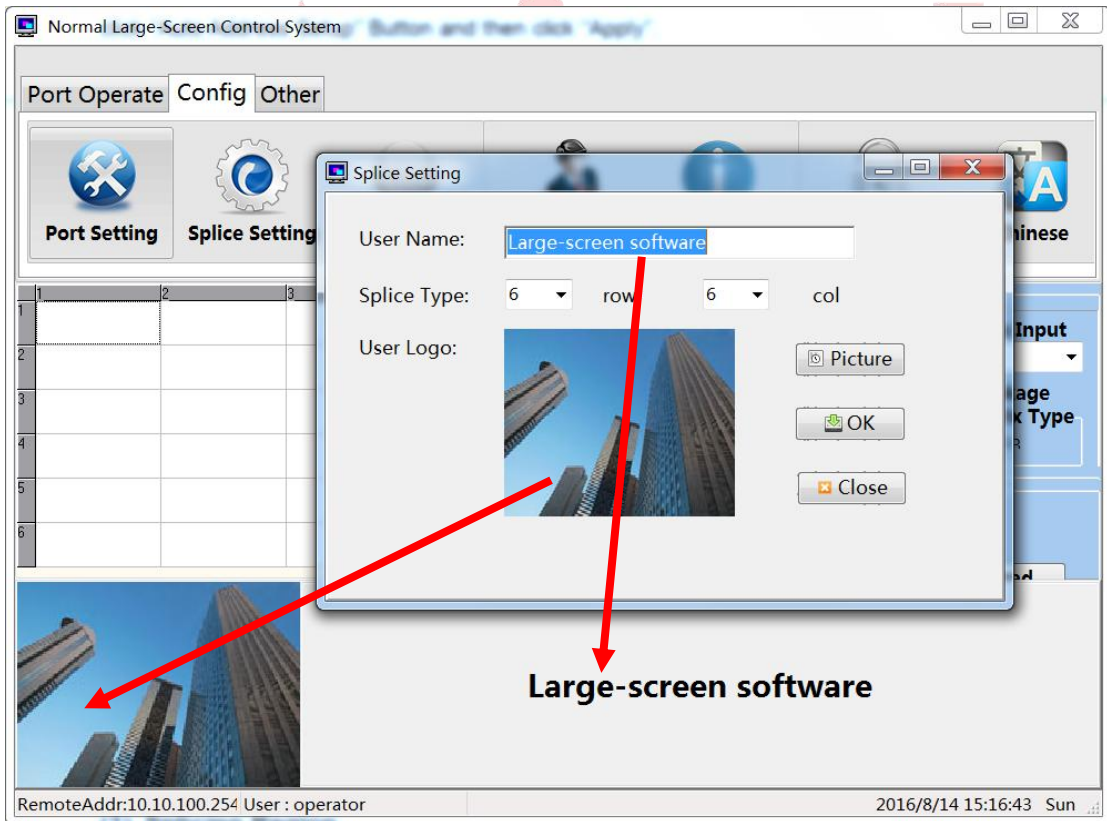

**Large-screen software**

**The Matrix config has the following features:**

Matrix configurations: choice of the use of matrix models and set the address

Port Match: Is the big screen location corresponding to the matrix output channel

For example: the large screen, a screen corresponding matrix of the first channel output, and so on

ID: is used to set the Matrix address if the address does not know, please contact Matrix manufacturers  
 The response time: matrix and splicing time between the command  
 Time interval: the matrix between the time the command

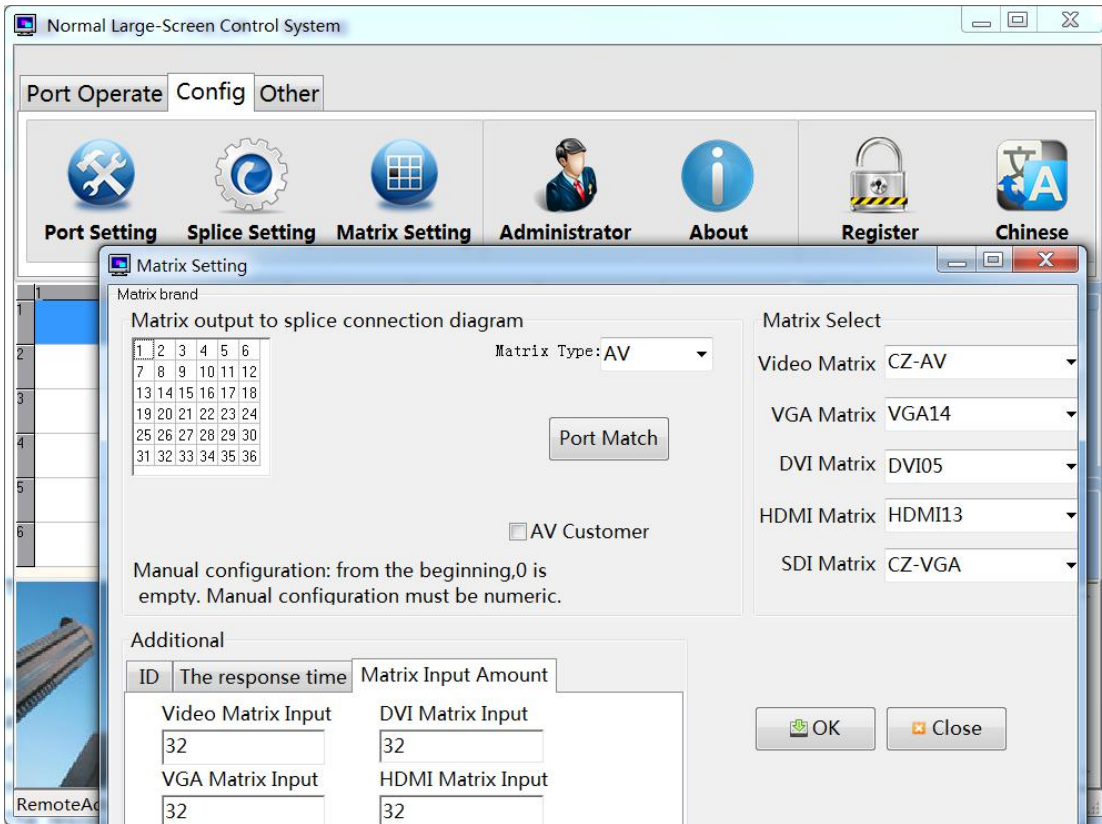

### (1) Splicing Region

First mouse to move to (1,1) coordinates of the box grid, press the button, then hold down the mouse to move to the (3,3) coordinates of the box grid, and then release the left button, the blue area that is, selected splicing Regional.

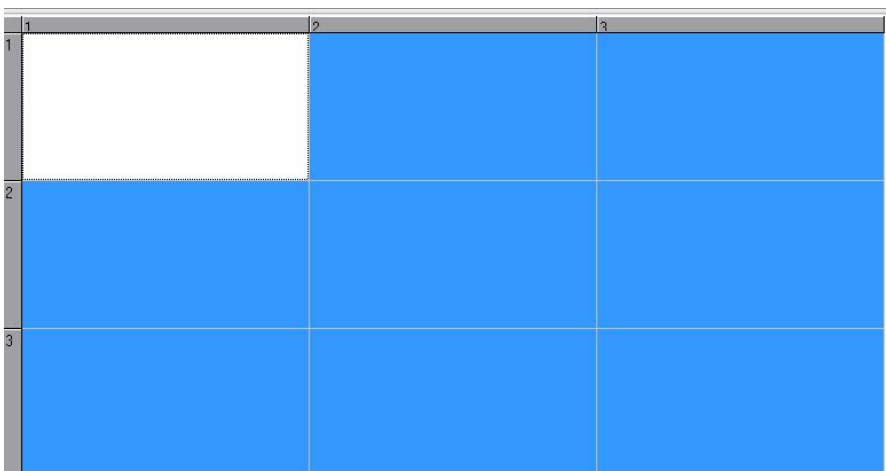

(2) Select the signal type, please contact your system to select: VIDEO, VGA,DVI,HDMI,VIDEO2 , and then click "Run" button. ("Single" button : each splicing unit single-screen display)

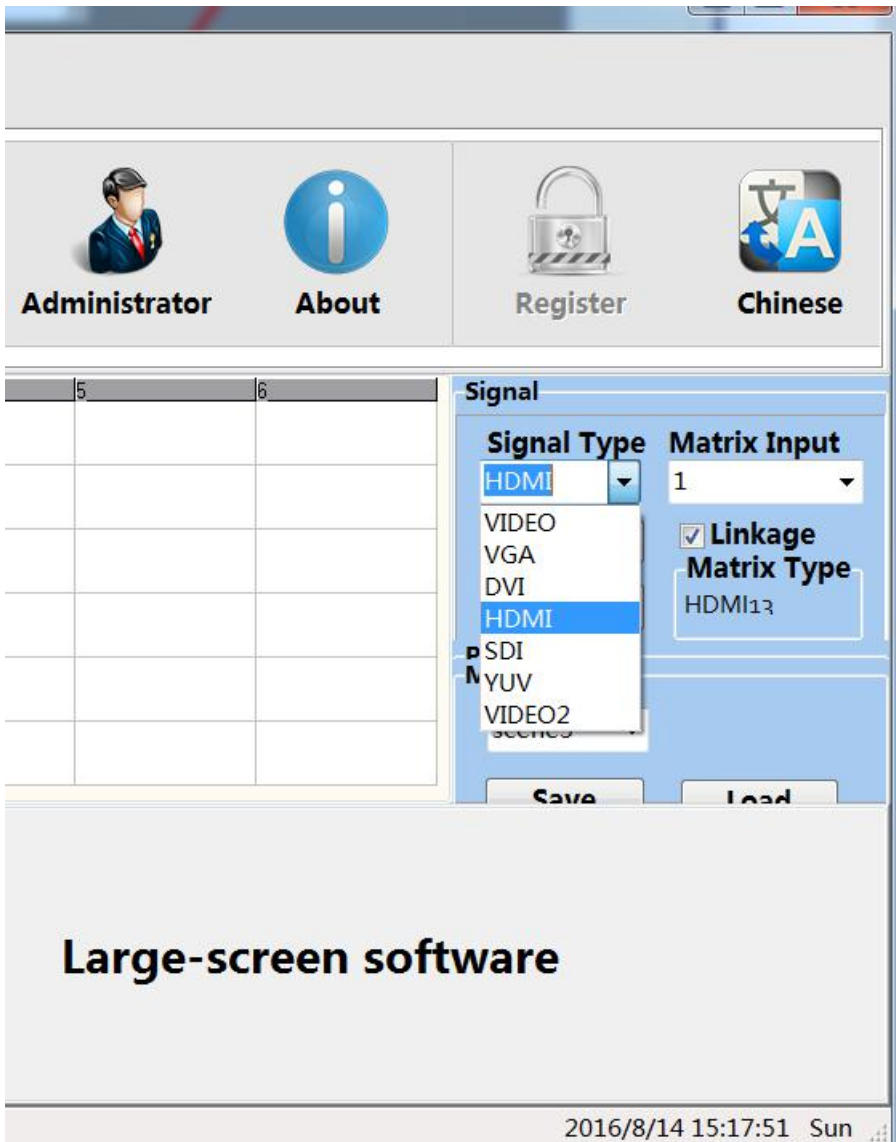

(3) If have matrix, with  $\sqrt{\quad}$  in the matrix linkage can choose to display matrix output channel. Specific settings with reference to the matrix description.

(4) Splicing region

	1	2	3	4	5	6
1						
2						
3						
4						
5						
6						

The above diagram, for example, the system is a 6X6 Splicing screen, and the need to coordinate (2,2) - (4,4) region spliced into a 3X3 large screen display.

Signal type is the "VIDEO" matrix channel 1.

**Operating according to look at an example:**

(1) First mouse to move to (2,2) coordinates of the box grid, press the button, then hold down the mouse to move to the (4,4) coordinates of the box grid, and then release the left button, the blue area that is, selected splicing Regional.

(2) confirm the model type "VIDEO" matrix channel "2", click "Run" button. (In the open state of the serial port)

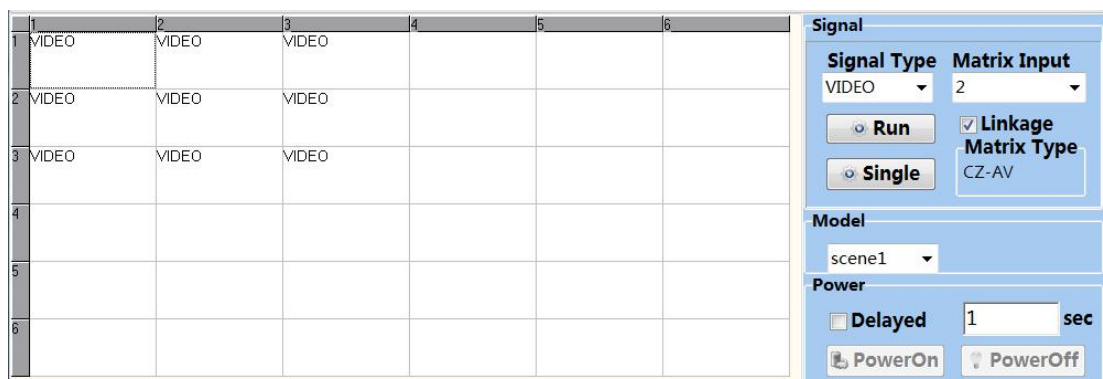

If you want to save the current settings splicing status, please click the button "Save". Splicing in the form will be stored in the memory of the controller. Turn off the power to restart, you can still load the previous state.

Note: "Local Save" takes about 2-3 seconds after clicking, do not line the other operations or turn off the power.

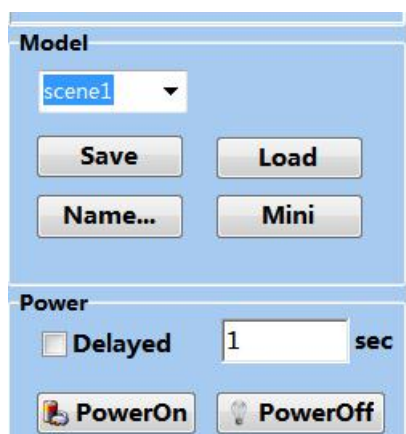

sianda®

Power Off: Click this button will close the selected area of the display unit power in standby mode

Power On: Click this button will open the selected area of the display unit power.

Choose "delayed 1 sec" and click "power on": Each display unit of the selected area will startup delay the last one for one second, do not line the other operations or turn off the power.

## 1.4. Main Features

### User Management

The system set up two operating authority:

(1) An administrator: with full privileges.

(2) Operator: You can only perform basic splicing operation and image adjustment function.

How: Click the main menu "Administrator"

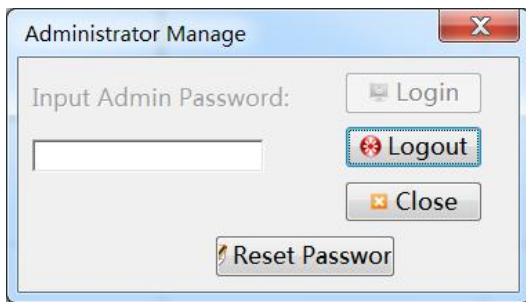

Administrator login,, you can modify the administrator login password.

The initial administrator login password is "12345", the password, such as modified keep in mind.

The status bar displays the current operating privileges.

### “Temperature Control” function introduction(as picture Below):

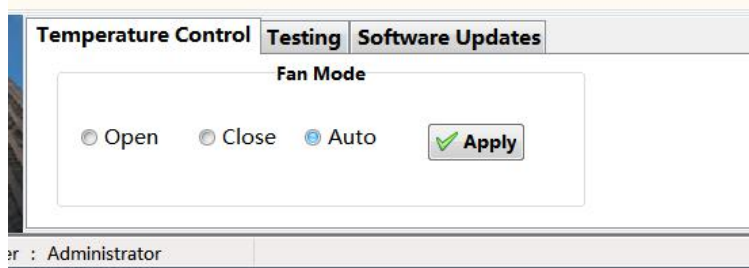

When use Temp. Control, you can choose “Auto” to recognize temperature automatically or “Manualsetting” to set the RunValue & StopValue, or choose “Open” / “Close” to keep on /off status, multiple combination provide much convenience for users.

### “Testing” function introduction(as below):

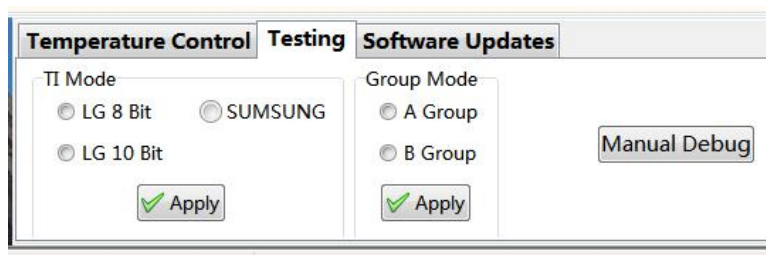

“Testing” is mainly for panel parameter adjustment. “Ti Mode” is the output signal format of image processor,

### Right-mouse Menu introduction(as below)



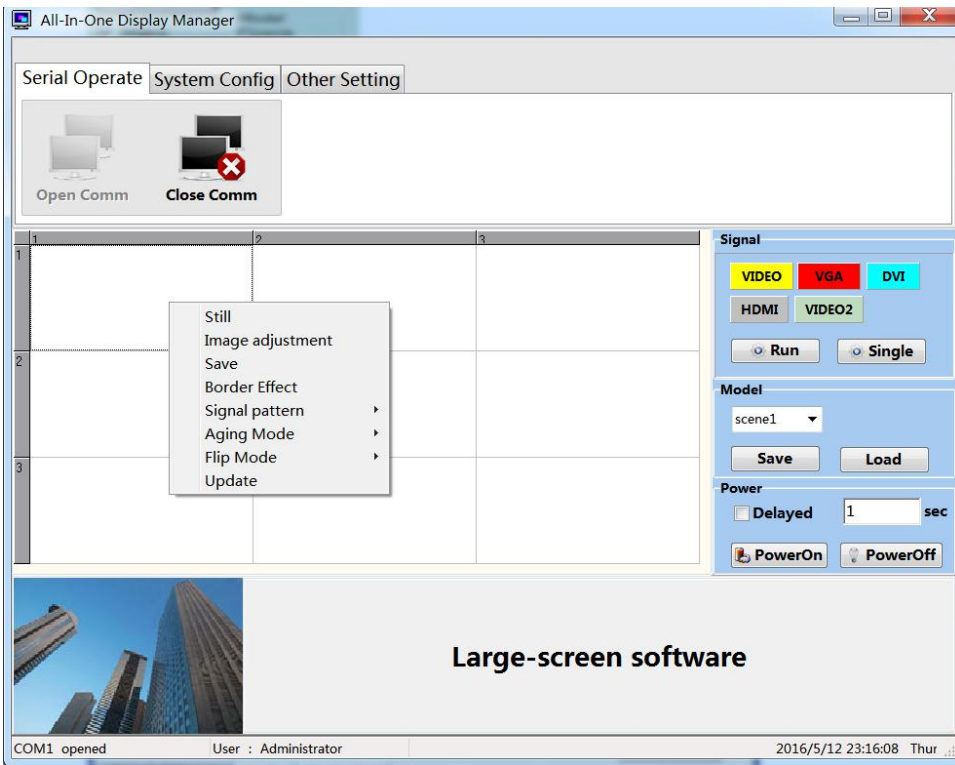

**Still:** motion picture still

**Image Adjustment:** choose this menu to open the image adjustment interface. This feature requires the Administrator mode. Specific follow-up to see "User Management" section.

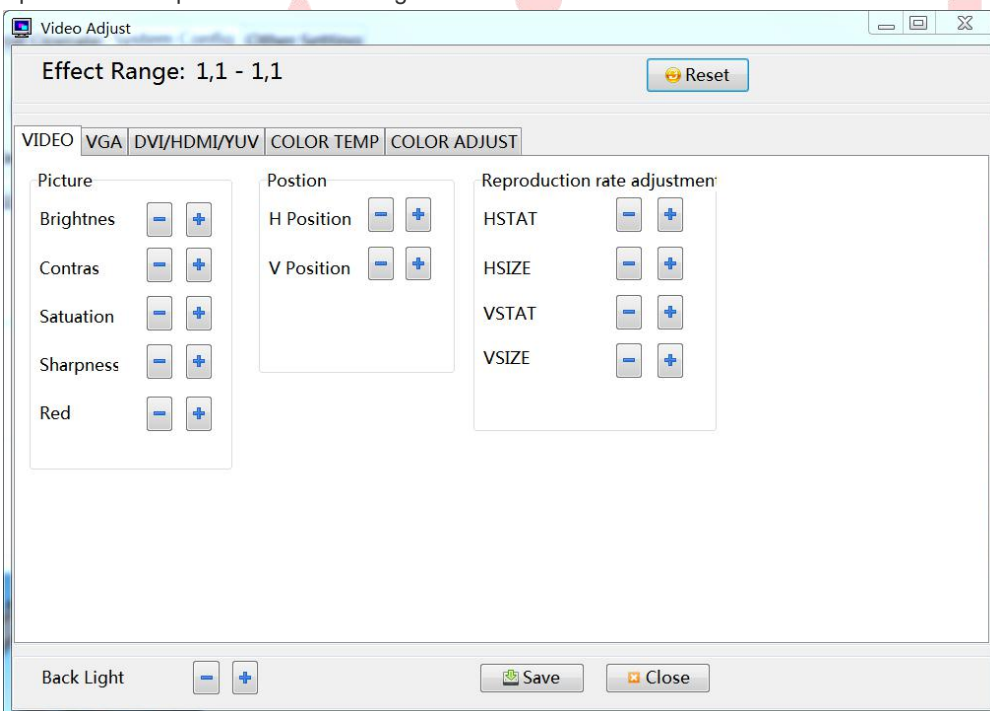

Adjustment range: selected coordinate unit area of the current operating area. All parameter adjustments will be effective in the selected cell area.

**VIDEO signal**, adjust the first page (VIDEO) within the parameters.

Picture

Brightness: Adjust the brightness of the screen image.

Contrast: adjust the brightness of the screen image.

Saturation: Adjust the image color depth extent.

Sharpness: Adjusts the screen image clarity and focus Poly.

Position

Horizontal position: adjust the screen image shows the horizontal position

Vertical Position: adjusts the screen image shows the vertical position

VGA signal, adjust the second page (VGA) within the parameters.

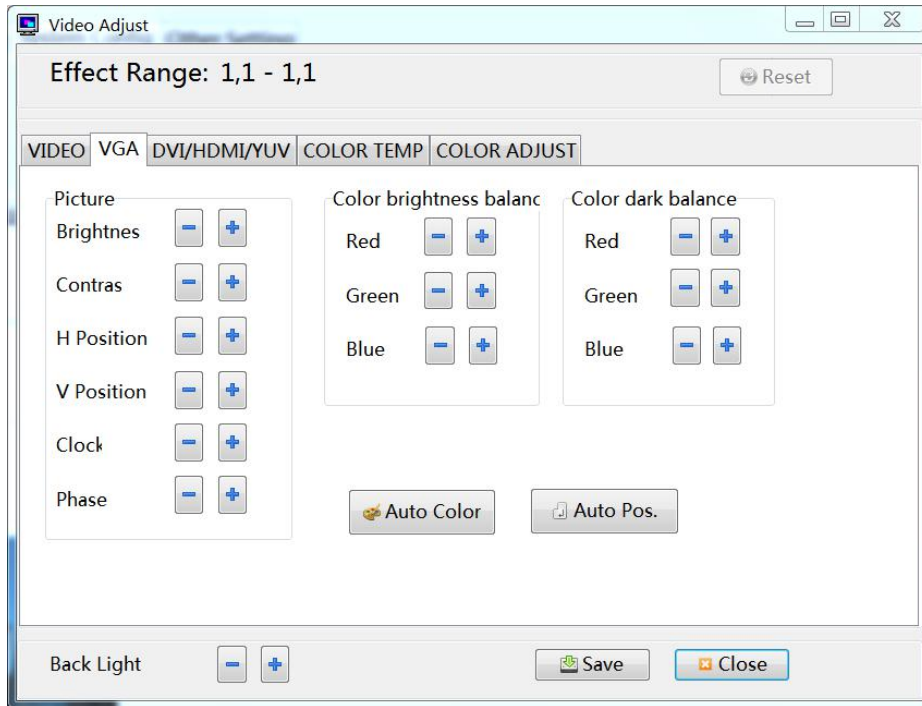

Picture

Brightness: Adjust the brightness of the screen image.

Contrast: adjust the brightness of the screen image.

Horizontal position: adjust the screen image shows the horizontal position

Vertical Position: adjusts the screen image shows the vertical position

Clock: Adjust the image sampling frequency

Phase: Adjust the image sampling phase

Color Bright Balance

Red: adjust the red component of the color temperature of light balance

Green: adjust the green component of the color temperature of light balance

Blue: Adjusts the color temperature of light balance blue component

Color dark balance

Red: adjust the color temperature to balance the dark red component

Green: adjust the color temperature balance of dark green component

Blue: Adjusts the color temperature of the dark to balance the blue component

Auto Color and Auto pos: the system to automatically adjust image color and display position.

Note: The " Auto Color or Auto pos " process takes about 3-6 seconds after clicking, do not line the other operations or turn off the power.

The reset of the machine: Click this button will be selected region display unit to adjust parameters back to factory state. .

Note: the reset of the machine process takes about 3-4 seconds after clicking, do not line the other operations or turn off the power.

**DVI/HDMI/YUVsignal**, adjust the second page (DVI HDMI YUV) within the parameters

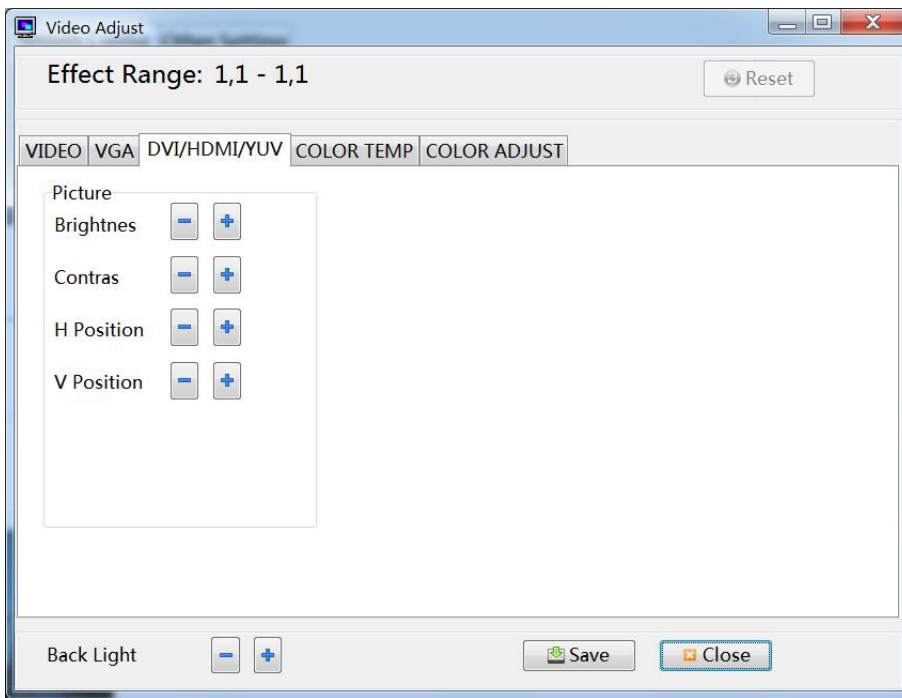

**Picture**

Brightness: Adjust the brightness of the screen image.

Contrast: adjust the brightness of the screen image.

Horizontal position: adjust the screen image shows the horizontal position

Vertical Position: adjusts the screen image shows the vertical position

**COLOR TEMP**

Color temperature

Color brightness adjustment

Red: the red component to adjust the color brightness balance

Green: the green component to adjust the color brightness balance

Blue: the blue component to adjusts the color brightness balance

Yellow: the yellow component Adjusts the color brightness balance

Purple: the purple component Adjusts the color brightness balance

Cyan: the cyan component Adjusts the color brightness balance

Gray:the gray component Adjusts the color brightness balance

**Color darkness adjustment**

Red: the red component to adjust the color darkness balance

Green: the green component to adjust the color darkness balance

Blue: the blue component to adjusts the color darkness balance

Yellow: the yellow component Adjusts the color darkness balance

Purple: the purple component Adjusts the color darkness balance

Cyan: the cyan component Adjusts the color darkness balance

Gray:the gray component Adjusts the color darkness balance



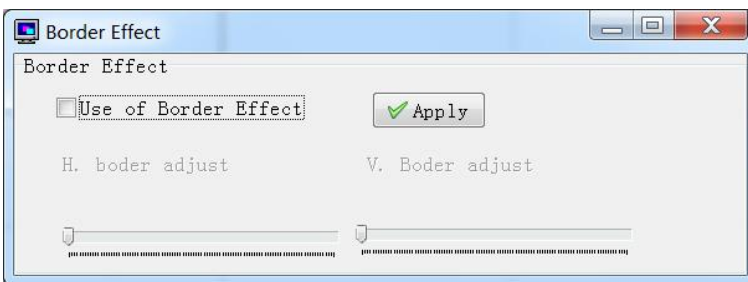
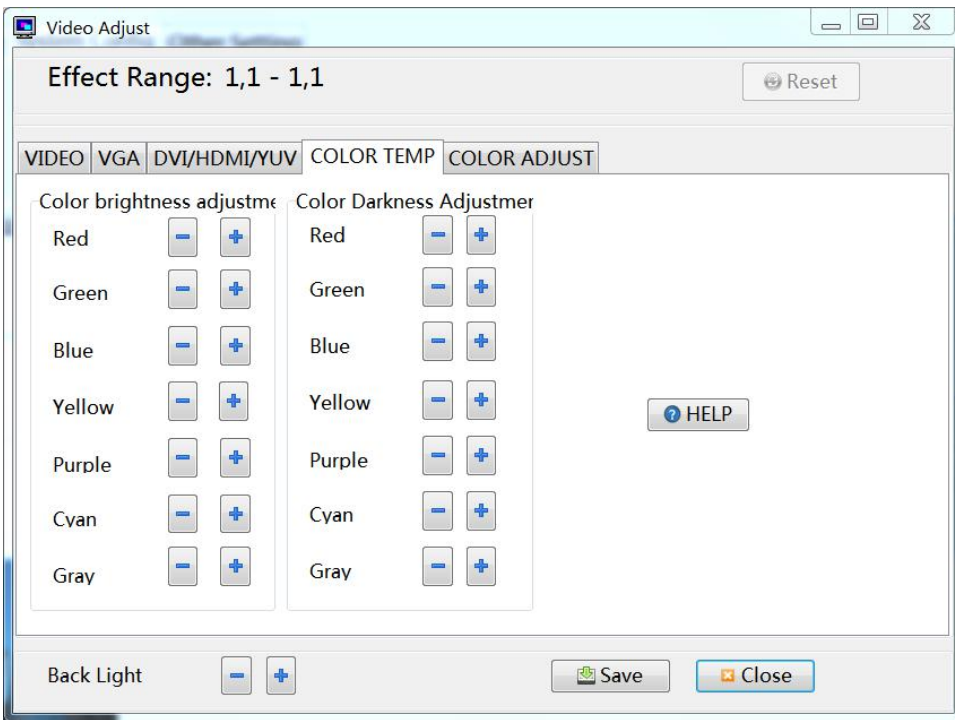

Adjust the level of frame size and the upper and lower frame size in order to achieve better results

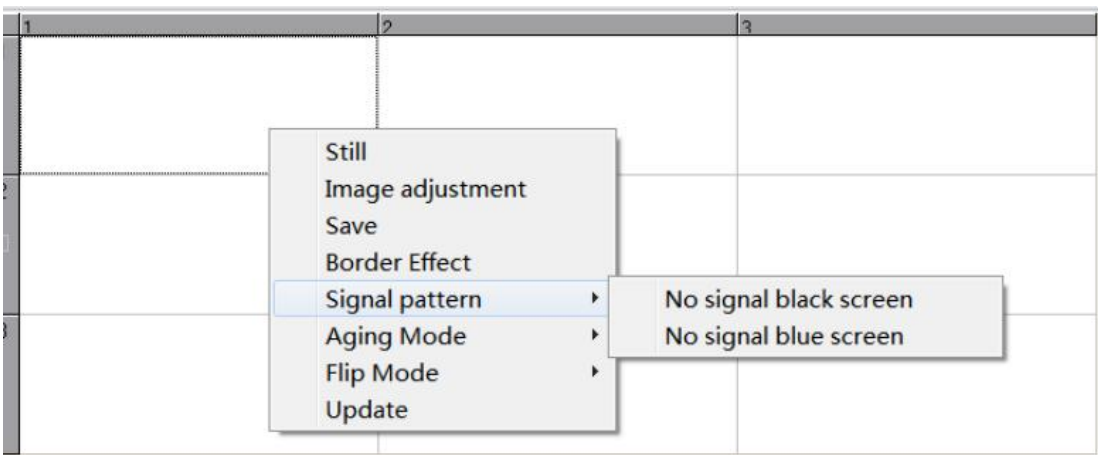

"Signal pattern" is to deal with the state of the screen with no-signal;

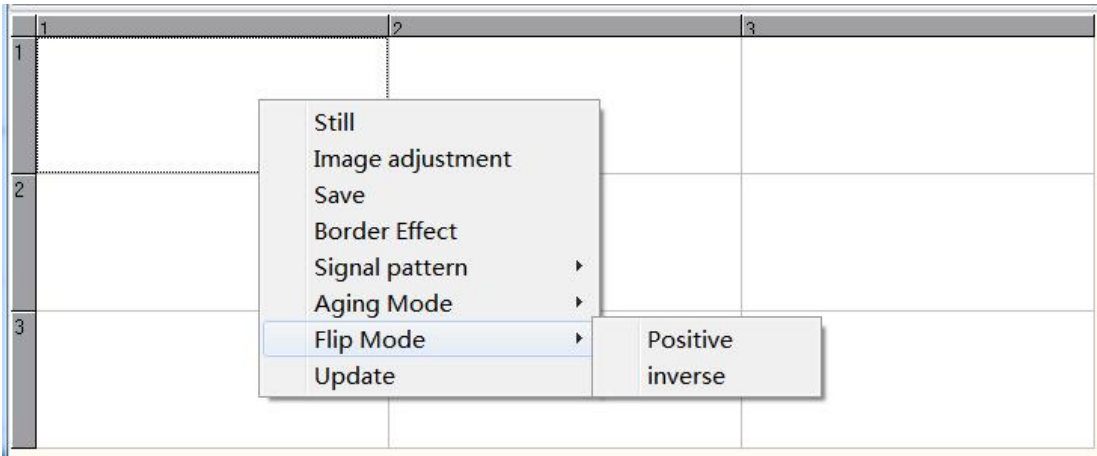

“Overturn Mode” is the direction of the image display;

## 2.1 Address Code Setting

(1) administrator login and then Click “Show SerialNo.” in Address Setting. Random SerialNo. will be displayed on all screens. Set the address of the screen according to the corresponding SerialNo.

For example:

	Column	Column	Column	Column
<b>ROW</b>	<b>Screen 1</b> SerialNo. 2358 R:1 C:1	<b>Screen 2</b> SerialNo. 4354 R:1 C:2	<b>Screen 3</b> SerialNo. 5369 R:1 C:3	<b>Screen 4</b> SerialNo. 6386 R:1 C:4
<b>ROW</b>	<b>Screen 5</b> SerialNo. 5383 R:2 C:1	<b>Screen 6</b> SerialNo. 6956 R:2 C:2	<b>Screen 7</b> SerialNo. 3856 R:2 C:3	<b>Screen 8</b> SerialNo. 7356 R:2 C:4
<b>ROW</b>	<b>Screen 9</b> SerialNo. 3396 R:3 C:1	<b>Screen 10</b> SerialNo. 8356 R:3 C:2	<b>Screen 11</b> SerialNo. 9352 R:3 C:3	<b>Screen 12</b> SerialNo. 1350 R:3 C:4
<b>ROW</b>	<b>Screen 13</b> SerialNo. 3559 R:4 C:1	<b>Screen 14</b> SerialNo. 5386 R:4 C:2	<b>Screen 15</b> SerialNo. 1398 R:4 C:3	<b>Screen 16</b> SerialNo. 7387 R:4 C:4

The address for screen 1 set as below:

Testing	Software Updates	Address setting	Aging Mode
SerialNo	<input type="text" value="2356"/>	<input type="button" value="Set"/>	
Address	Row <input type="text" value="1"/>	<input type="button" value="Lock"/>	
	Col <input type="text" value="1"/>	<input type="button" value="Refresh"/>	

input 2356 in SeralNo., 1 in Row, 1 in Col and click Set button, “Address set successfully” will be displayed on the screen 1,then click the Lock button,the address will be locked.

The address for screen 8 set as below:

Testing	Software Updates	Address setting	Aging Mode
SerialNo	<input type="text" value="7356"/>	<input type="button" value="Set"/>	
Address	Row <input type="text" value="2"/>	<input type="button" value="Lock"/>	
	Col <input type="text" value="4"/>	<input type="button" value="Refresh"/>	

input 7356 in SeralNo., 2 in Row, 4 in Col and click Set button, “Address set successfully” will be displayed on the screen 8,then click the Lock button,the address will be locked.

The address for screen 15 set as below:

Testing	Software Updates	Address setting	Aging Mode
SerialNo	<input type="text" value="1398"/>	<input type="button" value="Set"/>	
Address	Row <input type="text" value="4"/>	<input type="button" value="Lock"/>	
	Col <input type="text" value="3"/>	<input type="button" value="Refresh"/>	

input 1398 in SeralNo., 4 in Row, 3 in Col and click Set button, “Address set successfully” will be displayed on the screen 15,then click the Lock button,the address will be locked.

## 2.2. RJ45 network cable connection

Take 2x2 LCD video wall for example

## 2x2 LCD Video Wall Connection Diagram

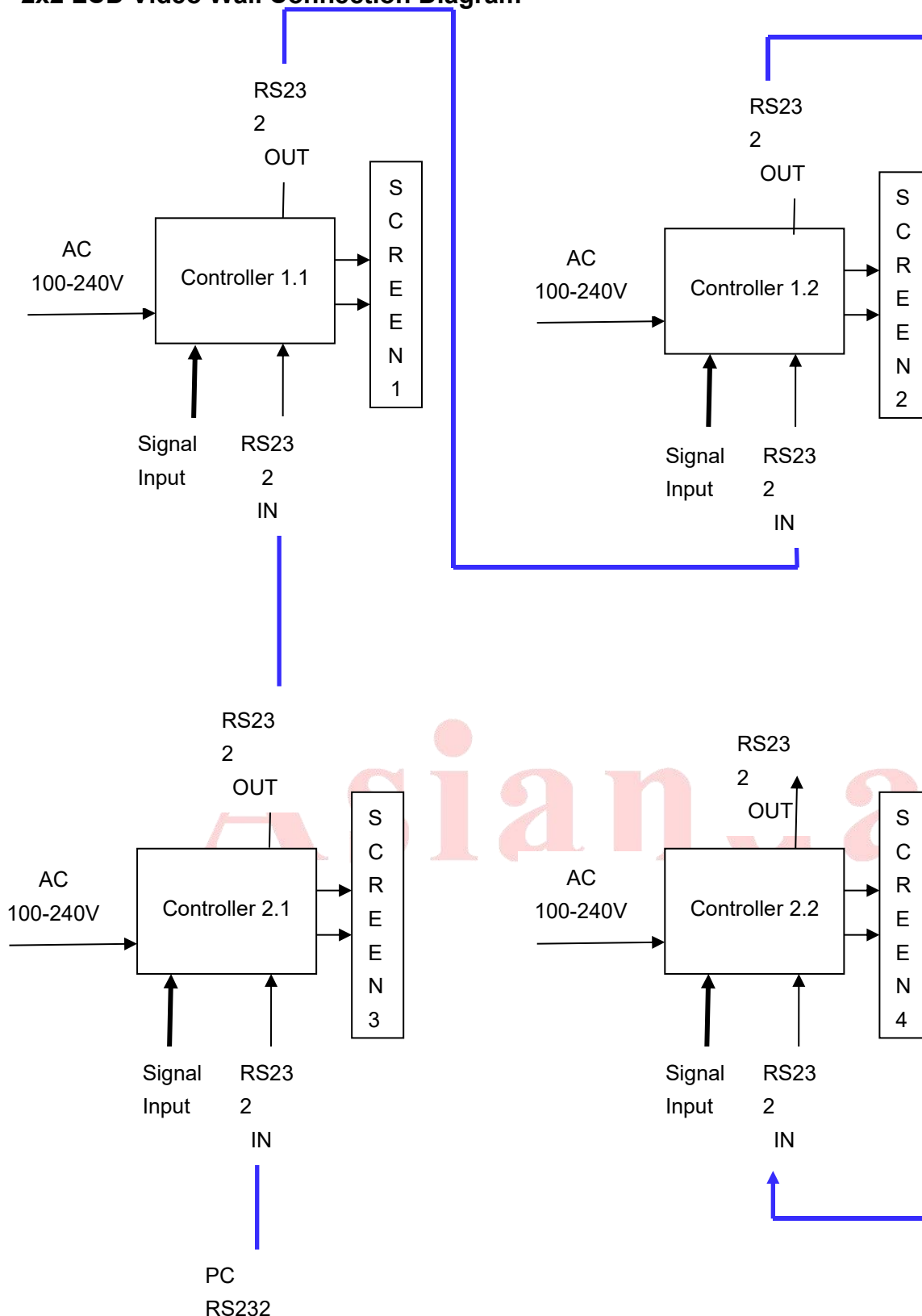

**Note: Blue line is connection of network cables.**

### 2.2 Common faults and solve solutions:

※ Fault 1: Can not turn on the power

Solutions: ① Check the power cable to ensure that both ends are properly inserted into the socket;

② Ensure that the power for providing is accurate and reliable.

※ Fault 2: No input signal information display

Solutions: ① Check the signal cable, make sure the connection reasonable;  
② Ensure that the associated peripherals are powered on;  
③ Ensure that the choice of input options match the input signal.

※ Fault 3: Remote control does not work

Solutions: ① Make sure there is no leakage for the battery;  
② Ensure that the remote control within its operating range;  
③ Ensure that the remote control point to display the remote control window;  
④ Ensure there are no obstructions between the remote control and free window.

※ Fault 4: There is flash point or stripe on the screen

Solutions: ① Equipment, electricity is not connected to the earth  
② Ensure that no emissions (cars, high-voltage cables or neon) or other possible sources of interference exist.

※ Fault 5: Image color or quality degradation

Solutions: ① Ensure that all channel settings (such as brightness, contrast, color, etc.) at reasonable adjustment;  
② Regarding the video settings for more information, please refer to the OSD introduced.

※ Fault 6: The location or size of the screen is incorrect

Solutions: ① Ensure that the screen position and size adjusted to a reasonable range.  
Automatic phase adjustment

※ Fault 7: The image or color is not correct

Solutions: ① Ensure connection of signal cable is reasonable;  
② When connected to a computer, you can change the resolution of the computer in order to obtain the correct images. The difference of computer output signal may effect the image display.

※ Fault 8: Warning message

Solutions: ① Ensure that the input signal line is fixed reasonable;  
② Select the correct input signal

※ Fault 9: LCD screen can not display in full-screen

Solutions: ① Check whether the digital DVI video cable is good  
② Signal line interface whether doing something wrong

※ Fault 10: LCD video wall been in blue screen

Solutions: ① whether to select the correct video channel  
② signal line off  
③ no signal input